



STADT BAD HÖTTING  
10400 10.04.2017



# Raum- und Fluchtwegplan der Mittelschule

- RAUFGANGSSTRAßE
- DRUCKER FLUCHTWEG
- FLUCHTWEG
- NOTRUFNUMMER
- NOTRUFNUMMER
- NOTRUFNUMMER

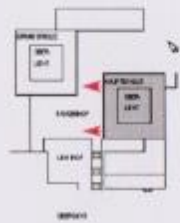
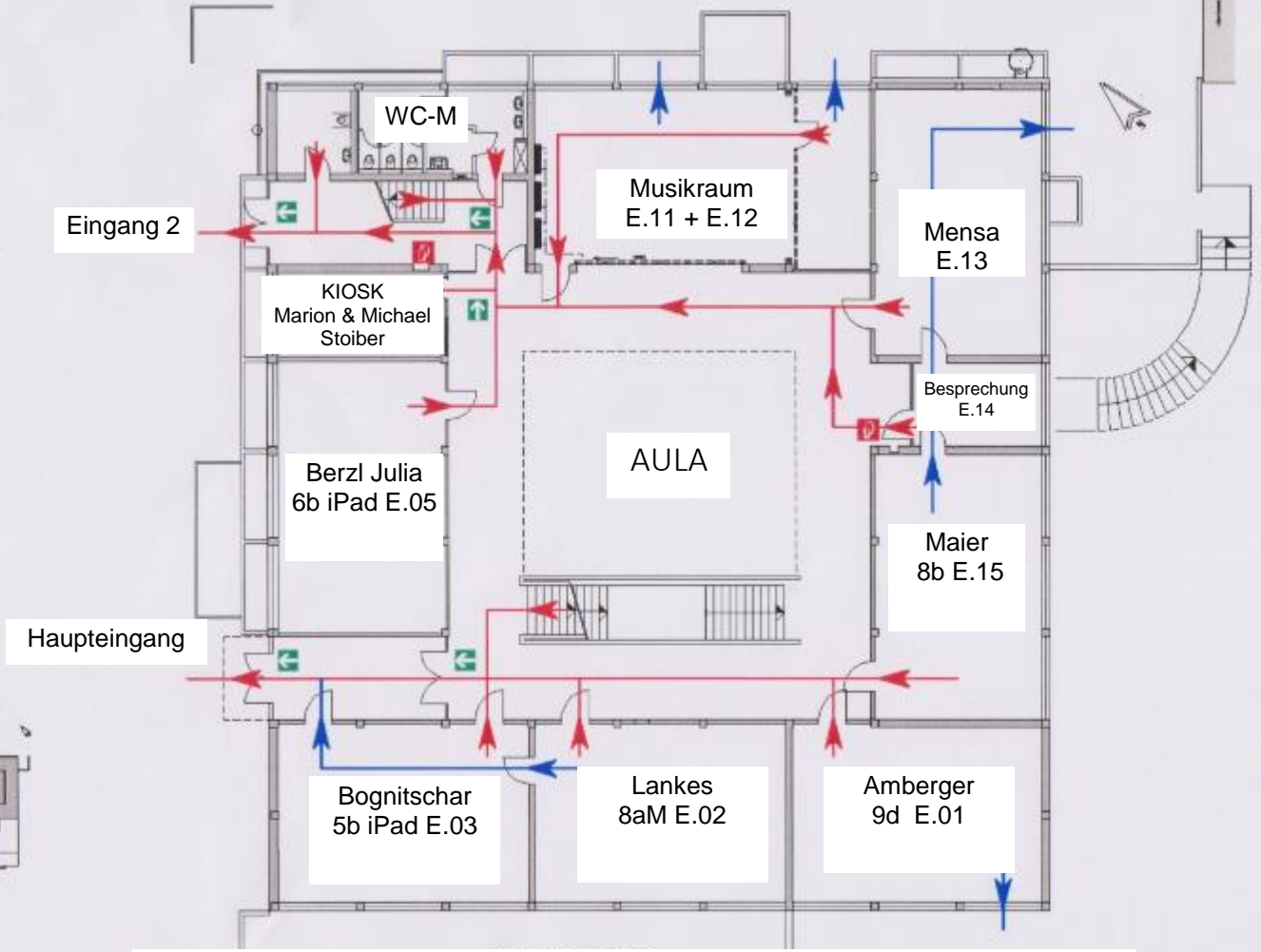

Mittelschule - EG



STADT BAD KÖTZING  
STADT: JUN 2001



# Raum- und Fluchtwegplan der Mittelschule

- HAUPT-FLUCHTWEG
- ZWISCHEN-FLUCHTWEG
- FLUCHTWEG-WEISUNG
- FEUERMELDER
- FEUER-GEFÄHRDUNG
- RAUCHABZUGSGANG

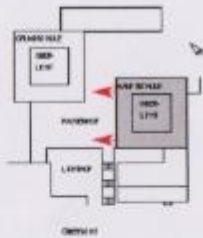
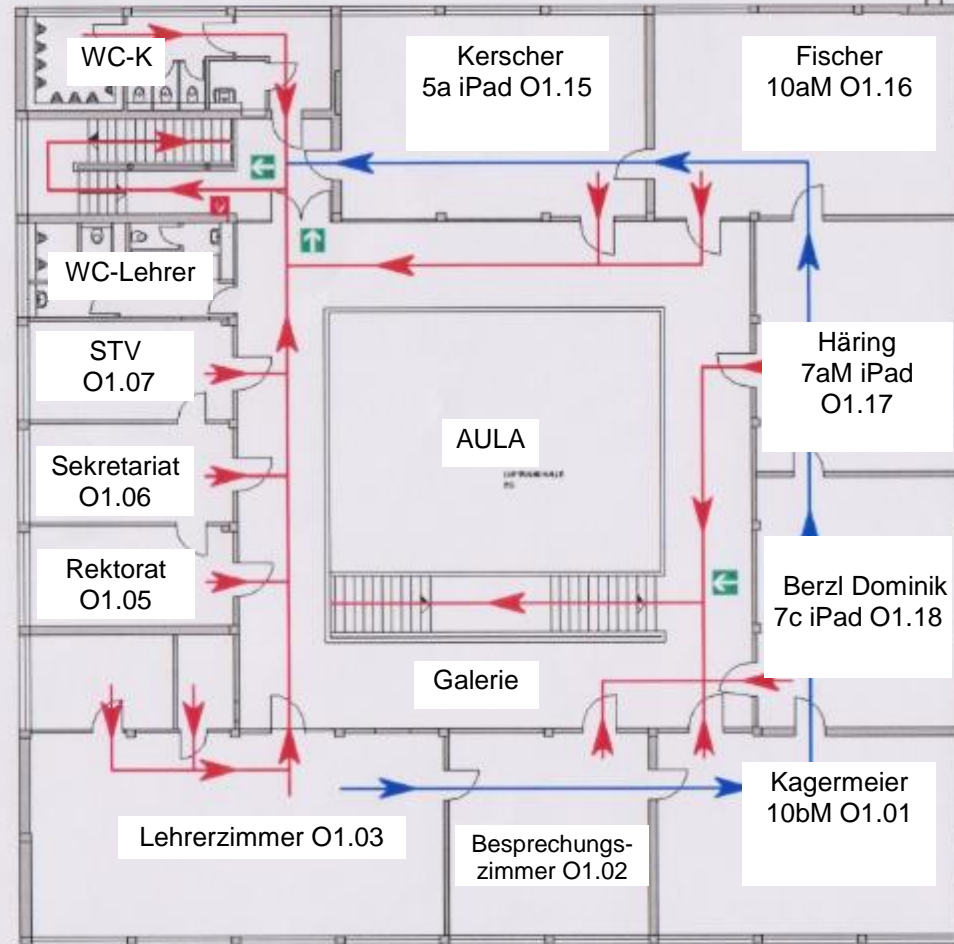

Mittelschule – 1. OG



STADT BAD HÖTTING  
INNSBRUCK



# Raum- und Fluchtwegplan der Mittelschule

- ROY-FLUCHTWEG
- ZWISCHEN-FLUCHTWEG
- AUSGANGS-FLUCHTWEG
- WECHSELSTELLE
- WECHSELSTELLE
- WECHSELSTELLE

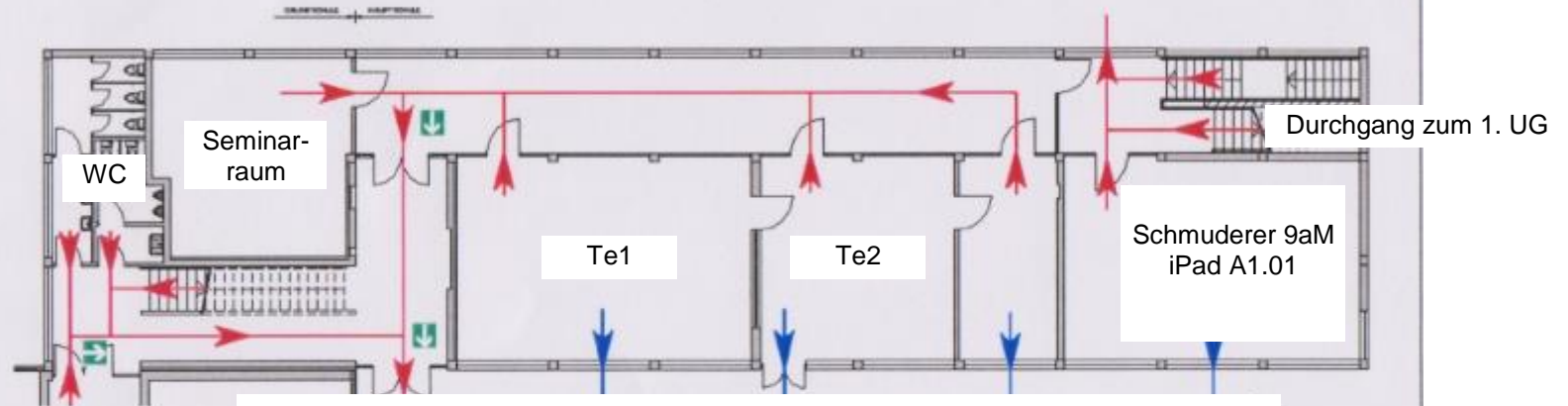

Anbau Mittelschule – EG

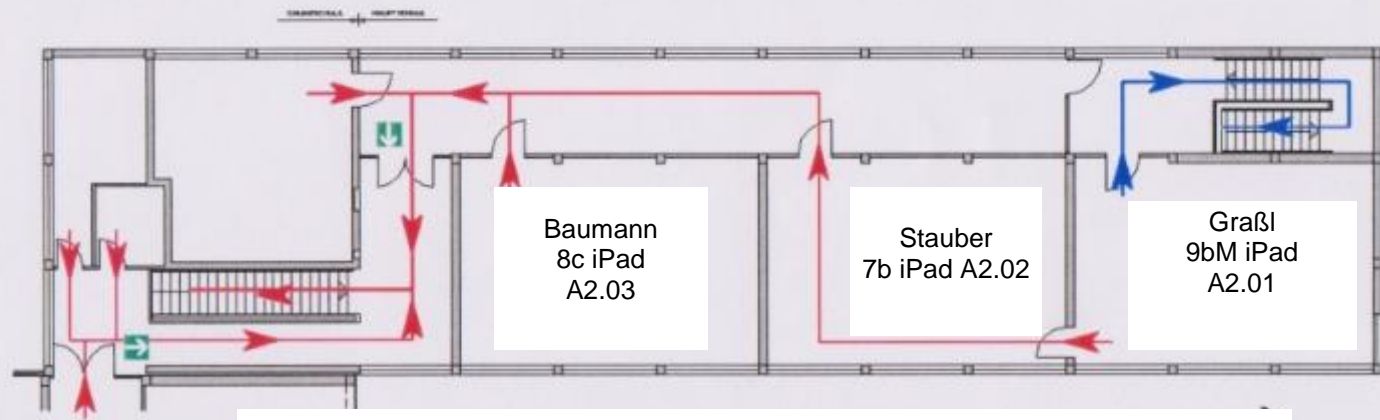

Anbau Mittelschule - OG

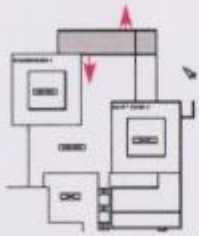



STADT BAD KÖTZING  
STAND 08.04.2017

# Raum- und Fluchtwegplan der Mittelschule

- HAUPT-FLUCHTWEG (Red arrow)
- ZWEITER-FLUCHTWEG (Blue arrow)
- FLUCHTWEG - BEZEICHNUNG (Green square)
- PERSONENLIFT (Red circle)
- PERSONENLIFTGEHÄUSE (Red square)
- RAUCHABMIGELN (Red square)

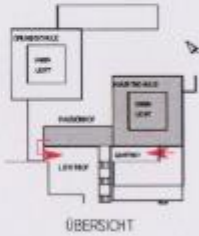
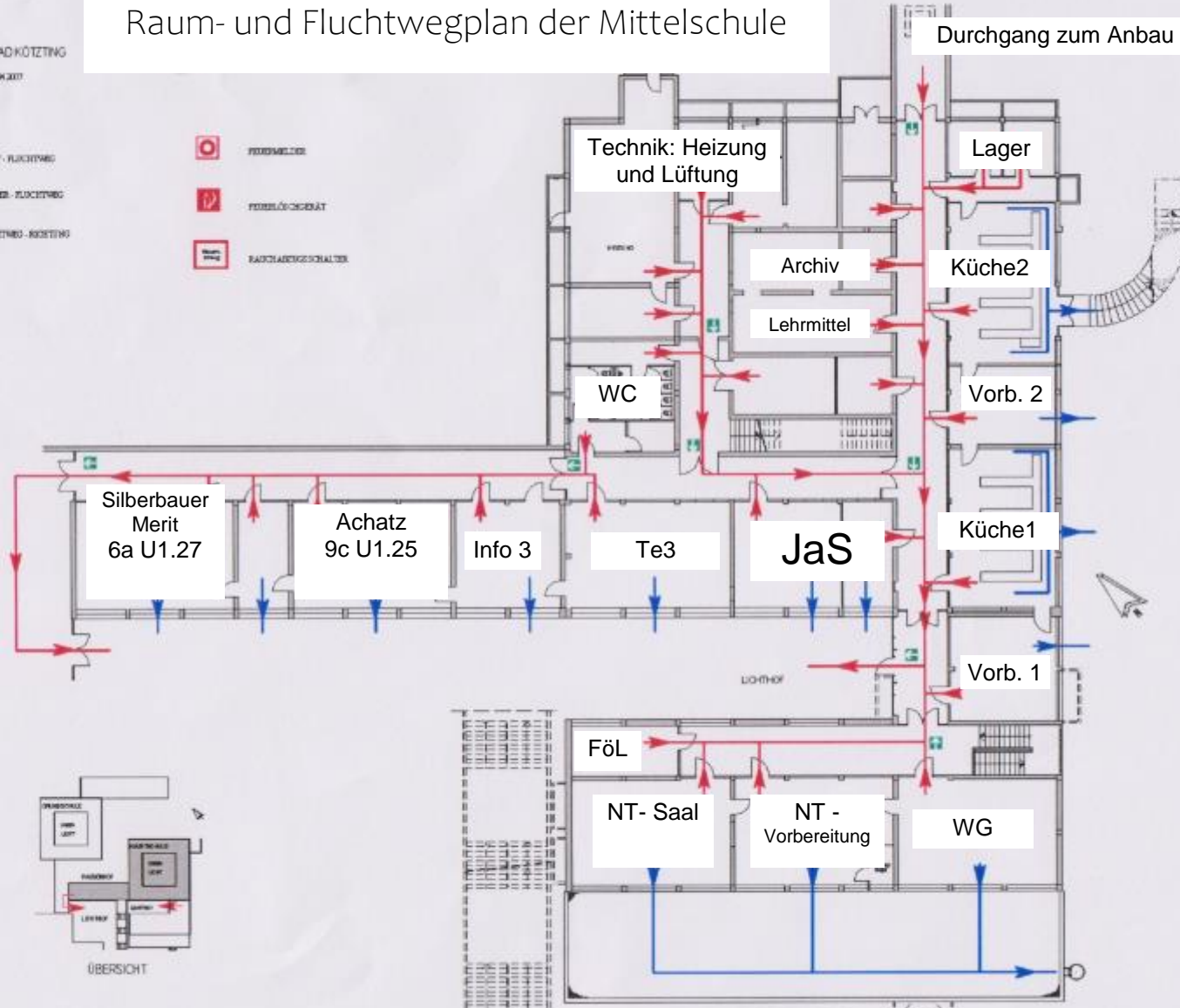

Mittelschule – 1. UG



STADT BAD KÖTZING  
17.04.2017



# Raum- und Fluchtwegplan der Mittelschule

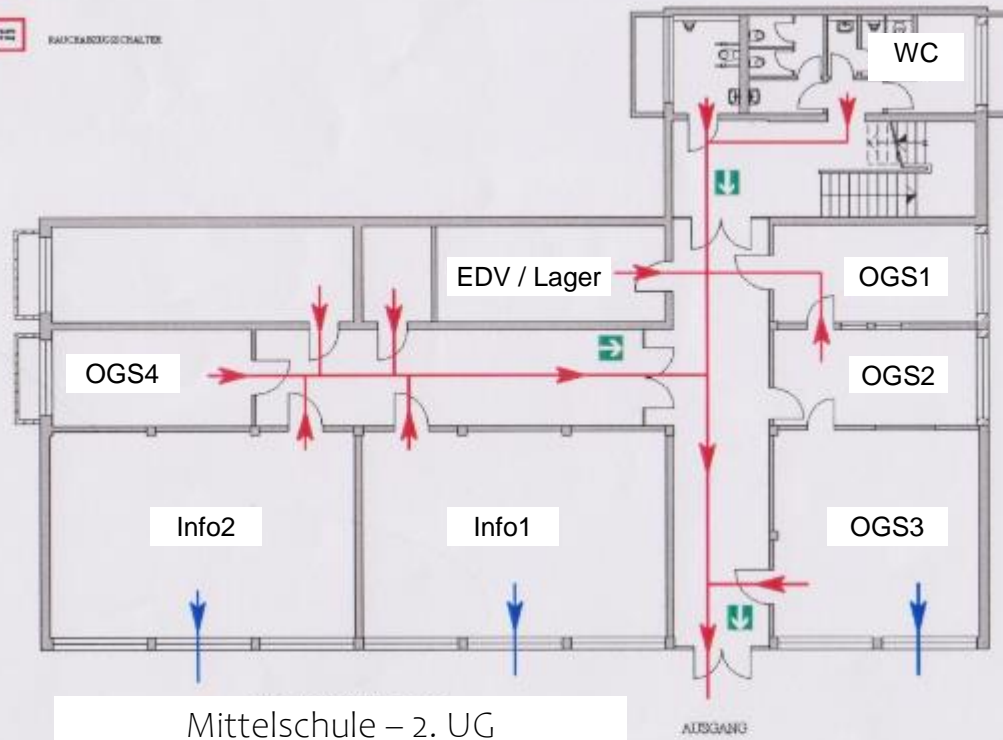

Mittelschule – 2. UG